

평면도
scale : None

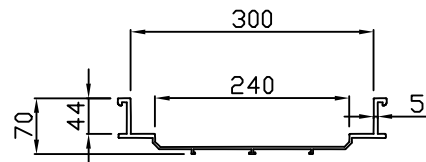

정면도
scale : None

연결소켓

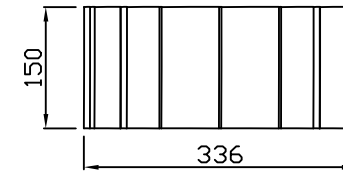

평면도
scale : None



정면도
scale : None

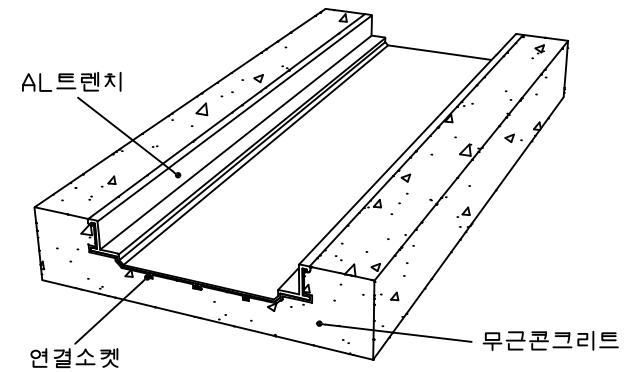

설치예시도
scale : None

PROJECT TITLE	AL트렌치	SUBJECT TITLE	DATE
MATERIAL		WEIGHT	SIZE
		Kg	330*70*3000